

BASE VIEW OF TURNSTILE

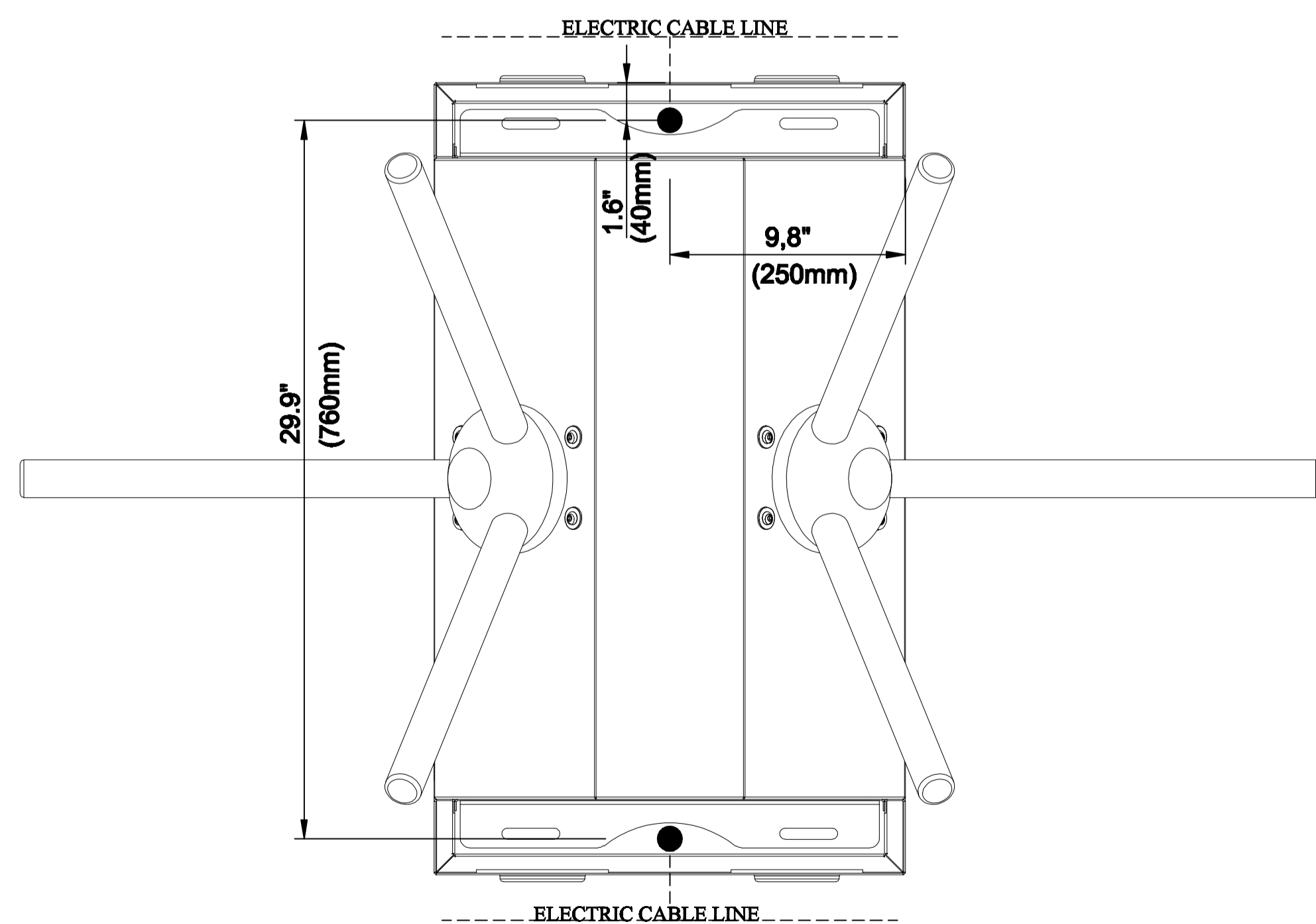

FRONT VIEW OF GROUND CONNECTION PLAQUE

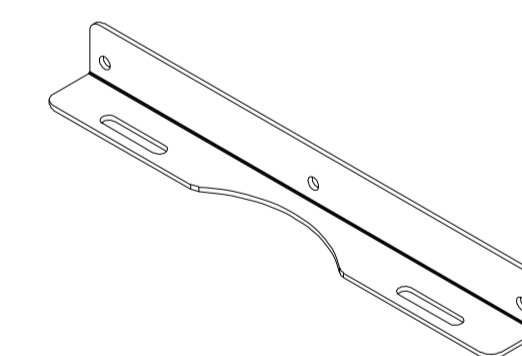
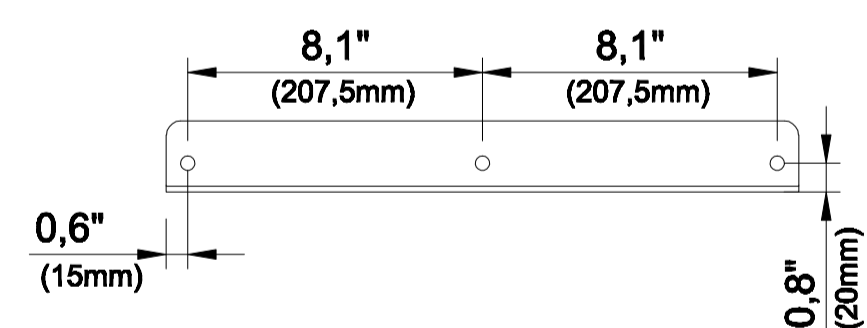

ISOMETRIC VIEW OF GROUND CONNECTION

BASE VIEW OF GROUND CONNECTION PLAQUE

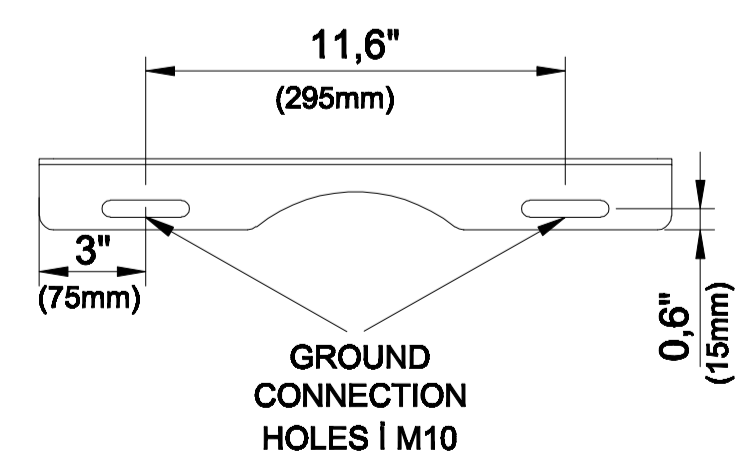

TECHNICAL DRAWING DIMENSIONING		REVISION
 TANSA 1962 SINCE TANSASEcurity.COM		
DRAWING MODEL		A4
LTT 303 DOUBLE		
SCALE : 1/15	PAGE 1 / 1	